

# STOCK BRAKE PIECES

Install with bleeder screw UP for proper bleeding

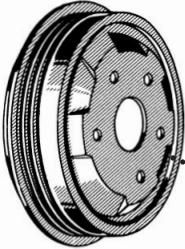

- **BLEEDER SCREW** .....0508 ..... \$1.95 ea.
- **WHEEL CYLINDER**
  - FRONT 1953-56 PASSENGER .....0504-RF ..... \$38.00 ea.
  - FRONT 1953-56 DRIVER .....0504-LF ..... \$38.00 ea.
  - REAR 1953-54 PASSENGER .....0506-RR ..... \$38.00 ea.
  - REAR 1953-54 DRIVER .....0506-LR ..... \$38.00 ea.
  - REAR 1955-56 PASSENGER .....0507-RR ..... \$34.00 ea.
  - REAR 1955-56 DRIVER .....0507-LR ..... \$34.00 ea.
- **WHEEL CYLINDER TO SHOE LINK** .....0503-SP ..... \$6.00 ea.



- **WHEEL CYLINDER REBUILD KITS** springs are included again.
  - FRONT (1 1/16" cups) .....0509-F ..... \$9.00 ea.
  - REAR 1953-54 (1" cups) .....0510-5354 ..... \$9.00 ea.
  - REAR 1955-56 (7/8" cups) .....0510-5556 ..... \$9.00 ea.
 We have kits without springs as well, and just the spring.
  - SPRING, FRONT .....0509-SP ..... \$4.50 ea
  - SPRING, REAR .....0510-SP ..... \$5.00 ea

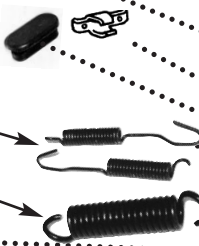
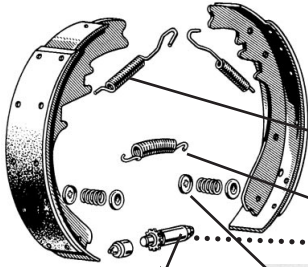

- **STOCK BRAKE WHEEL COMPONENTS**
  - BRAKE DRUM, FRONT .....0501-F ..... \$95.00 ea.
  - BRAKE DRUM, REAR .....0502-R ..... \$99.00 ea.
  - ADJUSTING HOLE COVER, Steel .....0543-STL ..... \$3.00 ea.
  - ADJUSTING HOLE COVER, Rubber .....0543-RB ..... \$1.25 ea.
  - RETRACTING SPRING, pr does 1 wheel .....0547 ..... \$6.50 pr.
  - SHOE ANCHOR SPRING .....0548 ..... \$4.50 ea.
  - ADJUSTER STAR WHEEL ASSEM. ....0541 ..... \$10.00 ea.
  - SHOE HOLD DOWN KIT .....0549 ..... \$9.00 kit
  - BRAKE SHOE SET, both FRONT wheels .....0545-F ..... \$39.50 set
  - BRAKE SHOE SET for both REAR wheels .....0545-R ..... \$39.50 set
 Brake shoes are exchange, core charge is \$8.50 per set, refund upon receipt

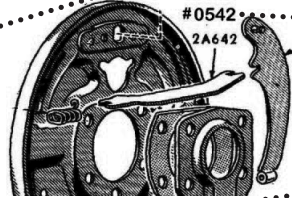
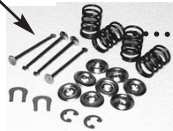

- **BRAKE SPREADER BAR** for E-Brake .....0542 ..... \$14.50 ea.  
 activator arms coming soon, get on first serve list for savings.

## BRAKE LINES AND HOSES



- **REAR BRAKE HOSE RETAINING CLIP** .....0554 ..... \$1.90 ea.
- **REAR BRAKE HOSE FRAME BRACKET** .....0530 ..... \$9.50 ea.
- **BRAKE BRACKET BOLT** .....80530 ..... \$1.25 ea.
- **REAR BRAKE HOSE** .....0525 ..... \$24.00 ea.  
 only one needed in center, goes to the center block fitting
- **CENTER BLOCK FITTING VENT** .....1336 ..... \$18.50 ea.
- **CENTER FITTING TO HOSE WASHER** .....0523 ..... \$1.20 ea.
- **REAR BRAKE CENTER BLOCK FITTING** .....0522 ..... \$15.50 ea
- F-250 ..... F2-0522 ..... \$18.50 ea

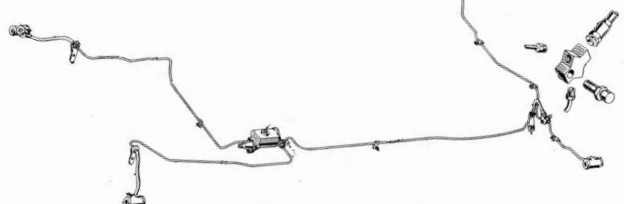
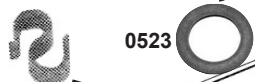
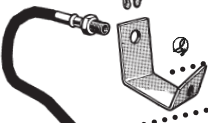

- **"S" LINE CLIP**, Joins fuel & brake line .....1636 ..... \$2.00 ea
- **BRAKE LINES**, for stock brakes, pre-bent 3/16" hardlines complete with proper ends and wrap installed, made from Ford specs.
  - Stainless .....5905-SS ..... \$175.00 kit
  - Stock Steel .....5904-SK ..... \$150.00 kit
- **D-Y-I BRAKE LINE KIT**, includes 30 feet of tube, fittings, unions, spring wrap and clips,
  - Stainless .....5901-S ..... \$139.95 kit
  - Plain Steel .....5901-K ..... \$75.00 kit
- **BRAKE LINE CLIP & BOLT** .....0526 ..... \$1.50 set
- **FRONT BRAKE HOSE**, use 2 .....0524 ..... \$20.00 ea.

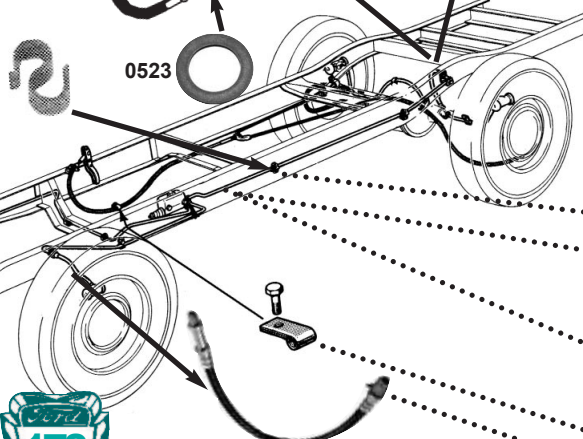

# STOCK BRAKES